

< Silicon RF Power MOS FET (Discrete) >

RD70HUF2

RoHS Compliance, Silicon MOSFET Power Transistor, 175MHz, 530MHz, 70W

DESCRIPTION

RD70HUF2 is MOS FET type transistor specifically designed for VHF/UHF RF power amplifiers applications.

FEATURES

1. Supply with Tape and Reel. 500 Units per Reel
2. Employing Mold Package
3. High Power and High Efficiency
 $P_{out}=75W_{typ}$, Drain Effi.=64% $_{typ}$
@ $V_{ds}=12.5V$ $I_{dq}=1.0A$ $P_{in}=5.5W$ $f=530MHz$
 $P_{out}=84W_{typ}$, Drain Effi.=74% $_{typ}$
@ $V_{ds}=12.5V$ $I_{dq}=1.0A$ $P_{in}=4.0W$ $f=175MHz$
4. Integrated gate protection diode

APPLICATION

For output stage of high power amplifiers in VHF/UHF band mobile radio sets.

RoHS COMPLIANT

RD70HUF2 is a RoHS compliant product.

This product includes the lead in high melting temperature type solders.

However, it is applicable to the following exceptions of RoHS Directions.

1. Lead in high melting temperature type solders. (i.e. tin-lead solder alloys containing more than 85% lead.)

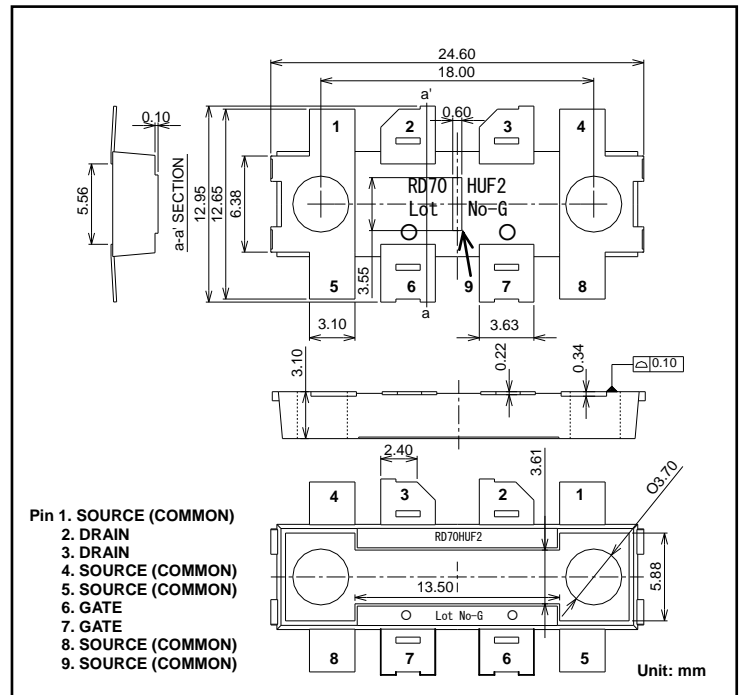

RD70HUF2

RoHS Compliance, Silicon MOSFET Power Transistor, 175MHz, 530MHz, 70W

ABSOLUTE MAXIMUM RATINGS ($T_c=25^\circ\text{C}$ UNLESS OTHERWISE NOTED)

SYMBOL	PARAMETER	CONDITIONS	RATINGS	UNIT
VDSS	Drain to Source Voltage	Vgs=0V	40	V
VGSS	Gate to Source Voltage	Vds=0V	-5/+10	V
Pch *	Channel Dissipation	Tc=25°C	300	W
Pin	Input Power	Zg=Zl=50Ω	12	W
ID	Drain Current	-	20	A
Tch	Channel Temperature	-	175	°C
Tstg	Storage Temperature	-	-40 to +175	°C
Rth j-c	Thermal Resistance	Junction to Case	0.5	°C/W

Note: Above parameters are guaranteed independently.

* Theoretical value in case of mounted on infinite heat sink.

ELECTRICAL CHARACTERISTICS ($T_c=25^\circ\text{C}$, UNLESS OTHERWISE NOTED)

SYMBOL	PARAMETER	CONDITIONS	LIMITS			UNIT
			MIN	TYP	MAX.	
IDSS*	Zero Gate Voltage Drain Current	VDS=37V, VGS=0V	-	-	150	μA
IGSS*	Gate to Source Leak Current	VGS=10V, VDS=0V	-	-	2.5	μA
VTH*	Gate Threshold Voltage	VDS=12V, IDS=1mA	1.6	2.0	2.4	V
Pout1	Output Power	f=530MHz**, VDS=12.5V,	-	75	-	W
ηD1	Drain Efficiency	Pin=5.5W, Idq=2x500mA	-	64	-	%
Pout2	Output Power	f=175MHz***, VDS=12.5V,	-	84	-	W
ηD2	Drain Efficiency	Pin=4.0W, Idq=2x500mA	-	74	-	%
VSWRT	Load VSWR Tolerance	All phase, VDS=16.3V increased after Pout adjusted to 70W(Zg/Zl=50Ω) by Pin(under f=135MHz***, VDS=12.5V and Idq=2x500mA)	20:1	-	-	VSWR

Note: Above parameters, ratings, limits and conditions are subject to change.

* Unilateral Measurement (Measured per Single Side)

** In Mitsubishi UHF Evaluation Board *** In Mitsubishi VHF Evaluation Board

RD70HUF2

RoHS Compliance, Silicon MOSFET Power Transistor, 175MHz, 530MHz, 70W

TYPICAL CHARACTERISTICS

(These are only typical curves and devices are not necessarily guaranteed at these curves.)

(These are Unilateral Measurement (Measured per Single Side))

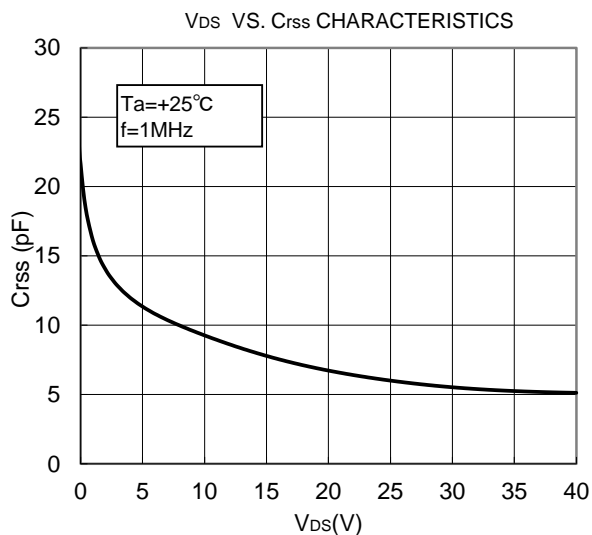
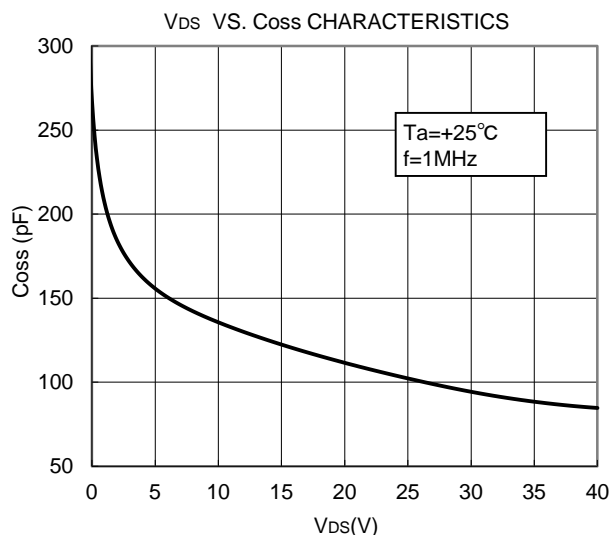
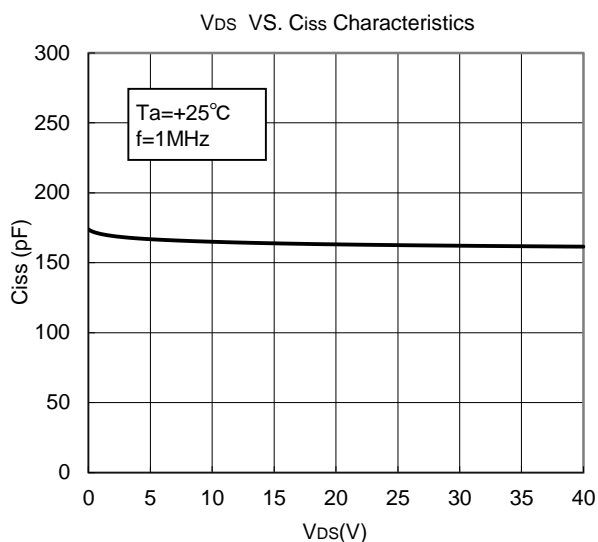
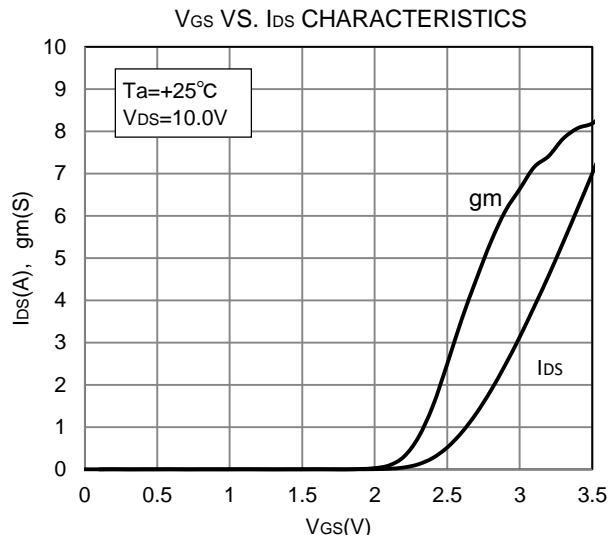
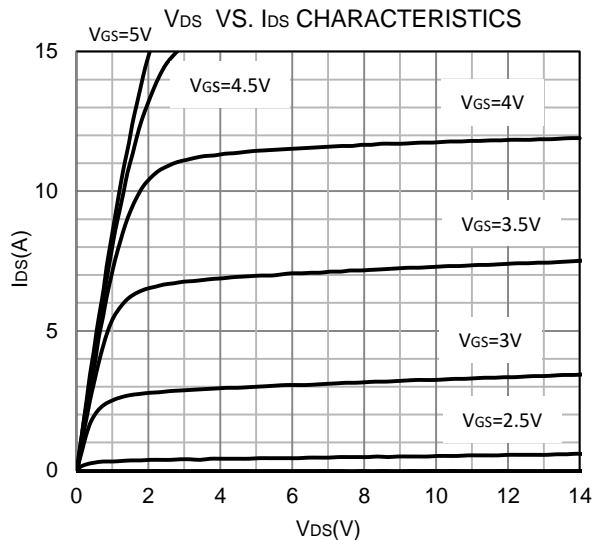

RD70HUF2

RoHS Compliance, Silicon MOSFET Power Transistor, 175MHz, 530MHz, 70W

VHF-band TYPICAL CHARACTERISTICS

(These are only typical curves and devices are not necessarily guaranteed at these curves.)

Frequency Characteristics @f=135 to 175MHz

Ta=+25deg.C,
Vds=12.5V, Idq=Total 1A/One side 0.5A, Pin=4.0W

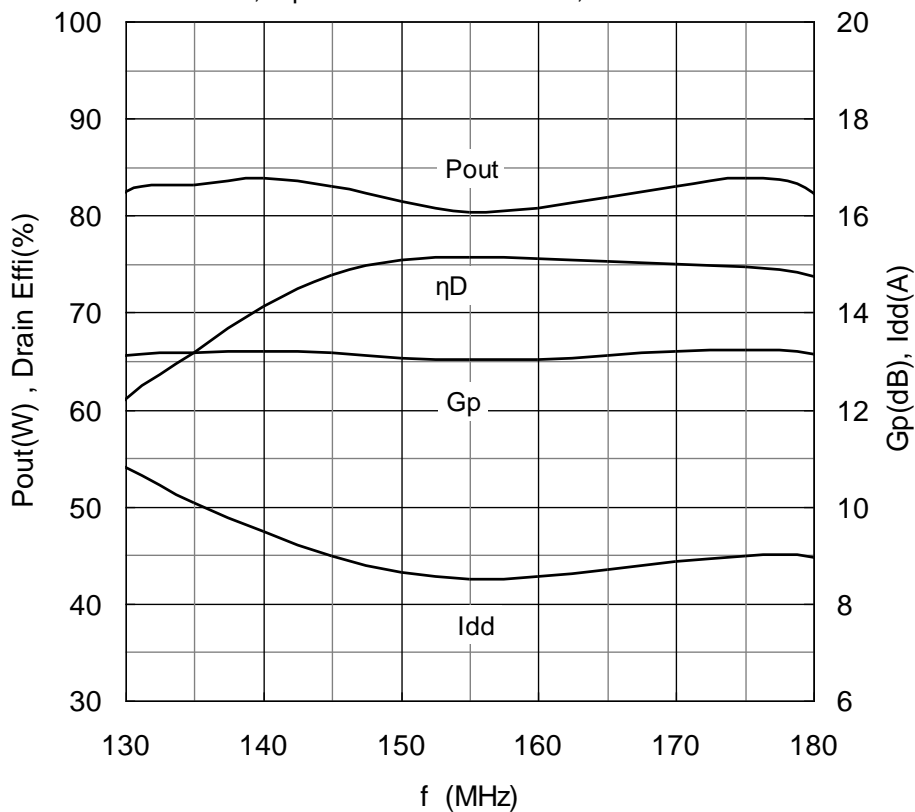

RD70HUF2

RoHS Compliance, Silicon MOSFET Power Transistor, 175MHz, 530MHz, 70W

VHF-band TYPICAL CHARACTERISTICS

(These are only typical curves and devices are not necessarily guaranteed at these curves.)

Output Power versus Input Power

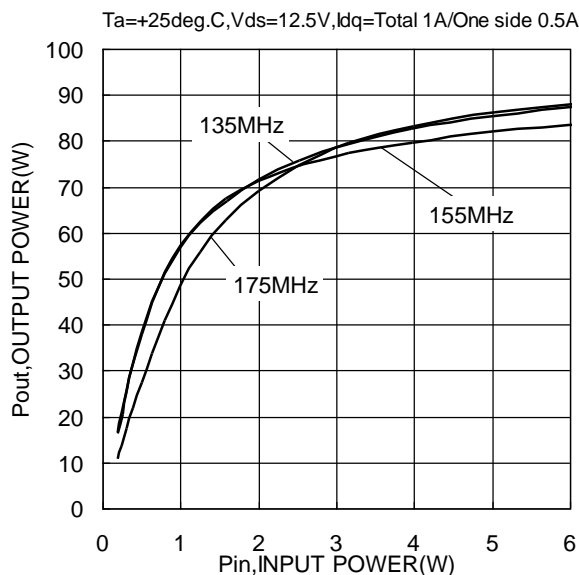

Input Return Loss versus Output Power

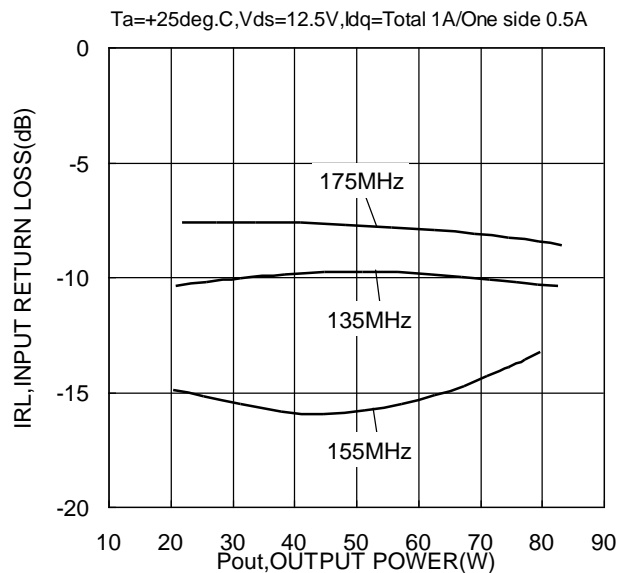

Gain versus Output Power

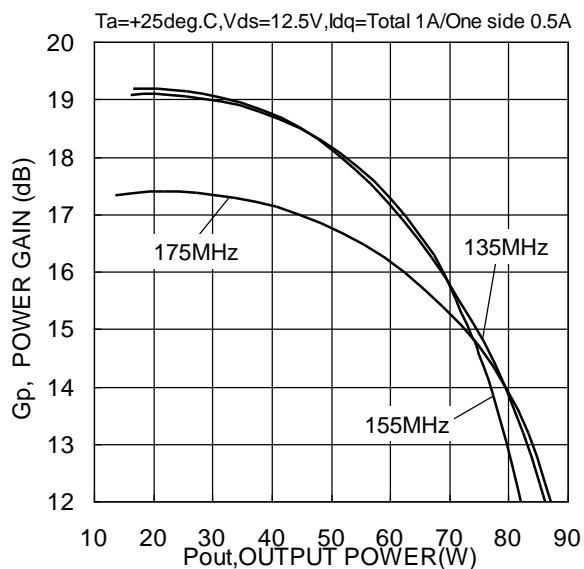

Drain Efficiency versus Output Power

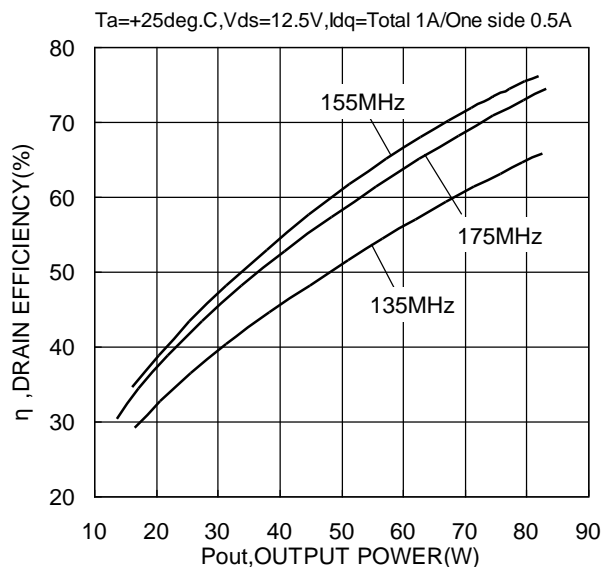

RD70HUF2

RoHS Compliance, Silicon MOSFET Power Transistor, 175MHz, 530MHz, 70W

VHF-band TYPICAL CHARACTERISTICS

(These are only typical curves and devices are not necessarily guaranteed at these curves.)

Output Power versus Biasing Current

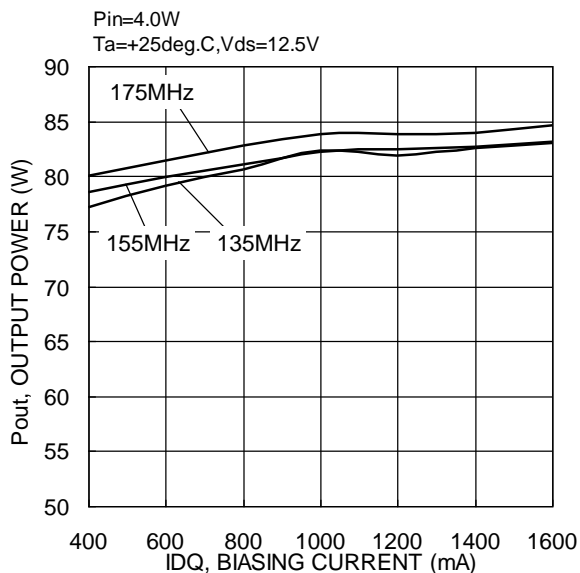

Drain Efficiency versus Biasing Current

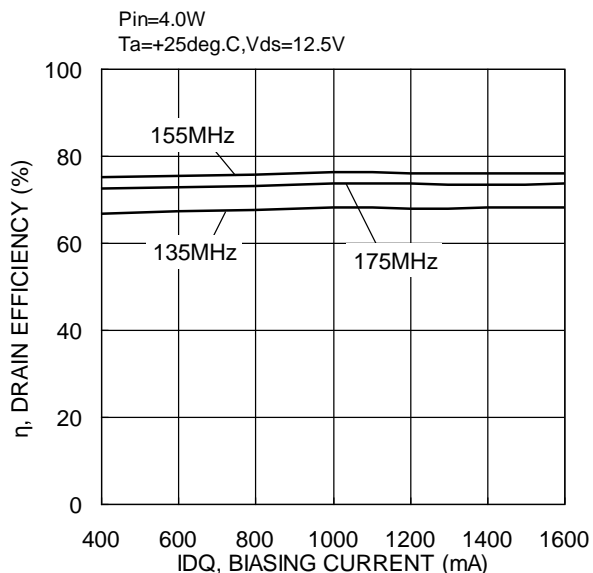

Output Power versus Supply Voltage

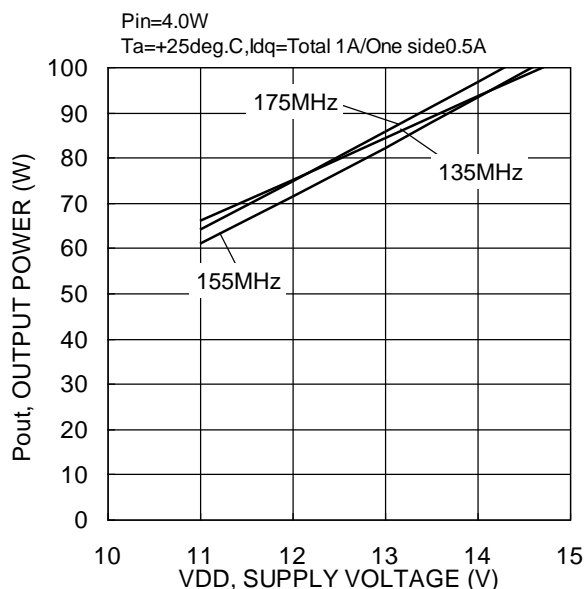

Drain Efficiency versus Supply Voltage

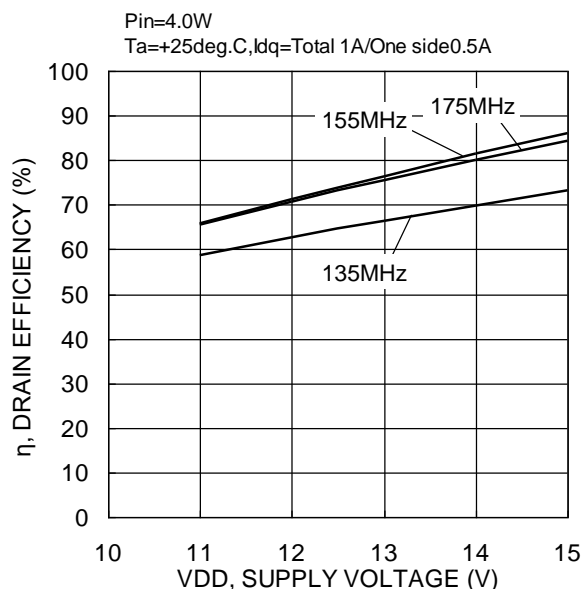

RD70HUF2

RoHS Compliance, Silicon MOSFET Power Transistor, 175MHz, 530MHz, 70W

UHF-band TYPICAL CHARACTERISTICS

(These are only typical curves and devices are not necessarily guaranteed at these curves.)

Frequency Characteristics @f=450 to 530MHz

Ta=+25deg.C,
Vds=12.5V, Idq=Total 1A/One side0.5A, Pin=5.5W

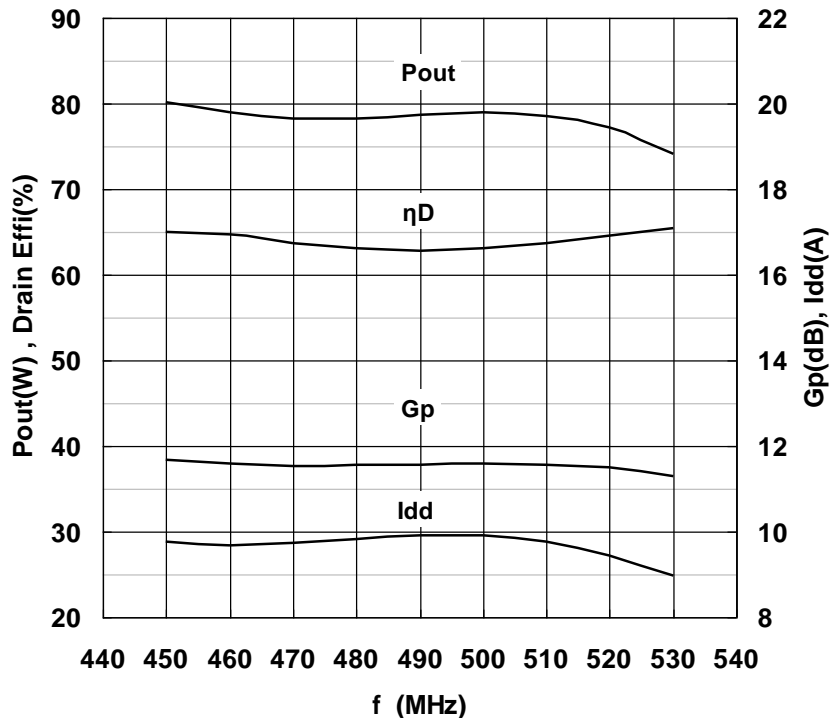

RD70HUF2

RoHS Compliance, Silicon MOSFET Power Transistor, 175MHz, 530MHz, 70W

UHF-band TYPICAL CHARACTERISTICS

(These are only typical curves and devices are not necessarily guaranteed at these curves.)

Output Power versus Input Power

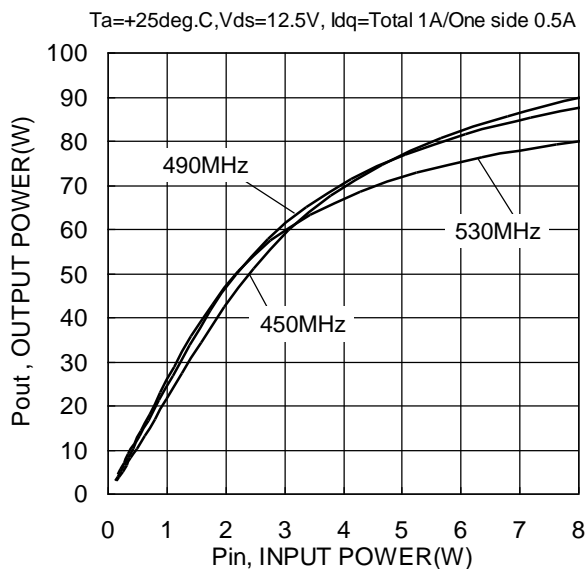

Input Return Loss versus Output Power

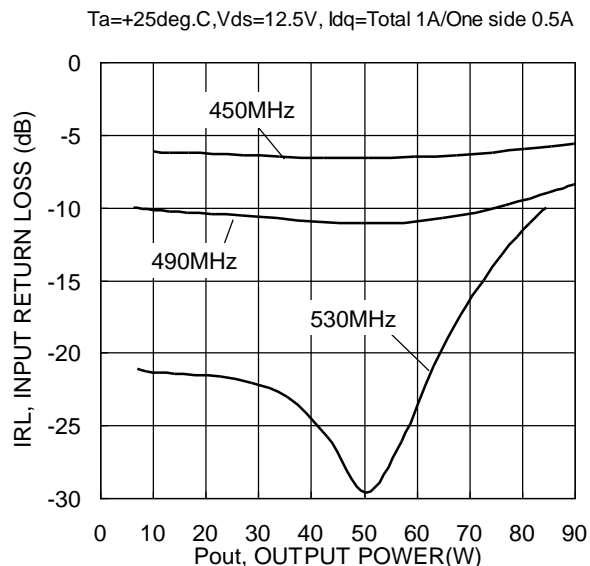

Gain versus Output Power

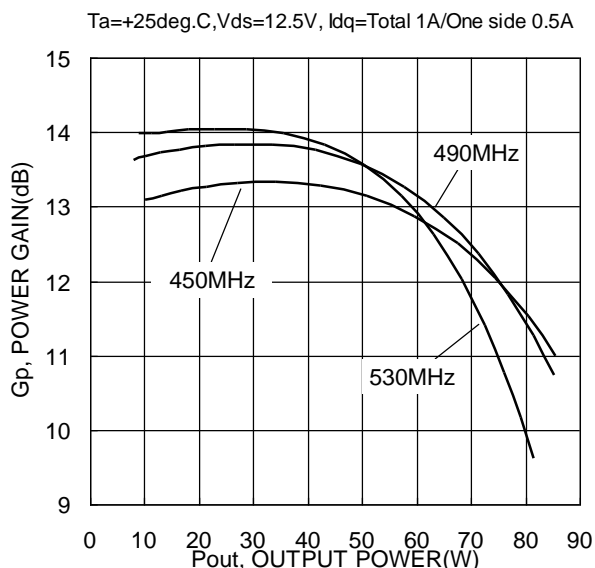

Drain Efficiency versus Output Power

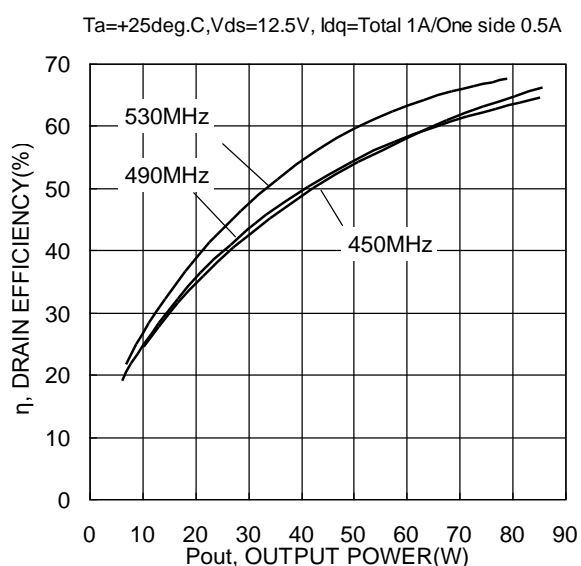

RD70HUF2

RoHS Compliance, Silicon MOSFET Power Transistor, 175MHz, 530MHz, 70W

UHF-band TYPICAL CHARACTERISTICS

(These are only typical curves and devices are not necessarily guaranteed at these curves.)

Output Power versus Biasing Current

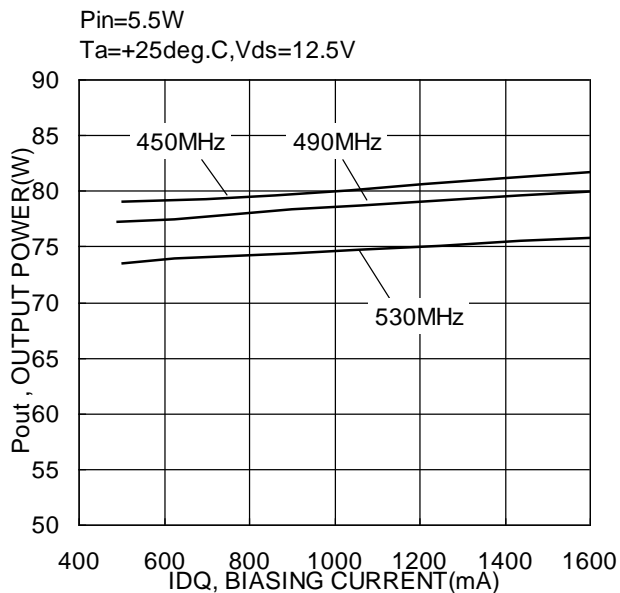

Drain Efficiency versus Biasing Current

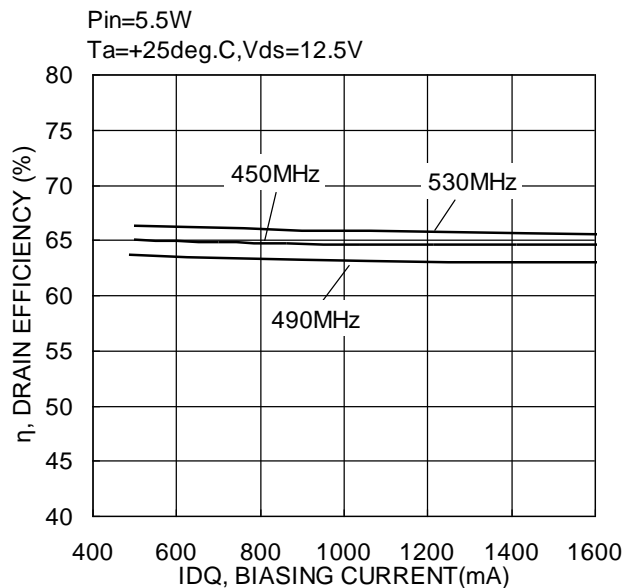

Output Power versus Supply Voltage

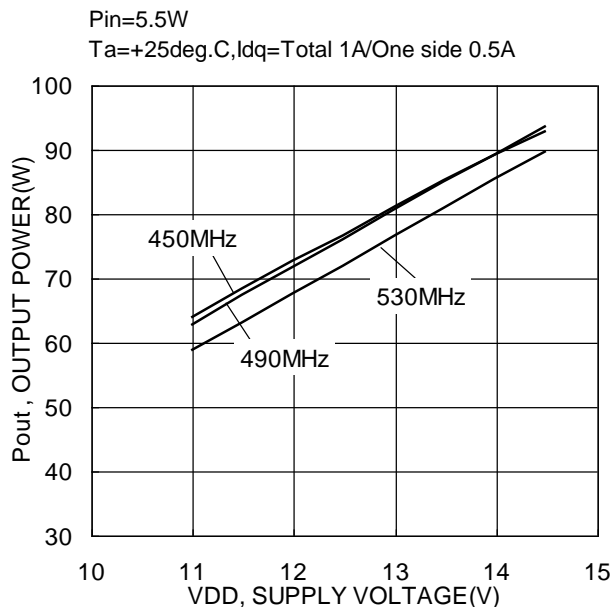

Drain Efficiency versus Supply Voltage

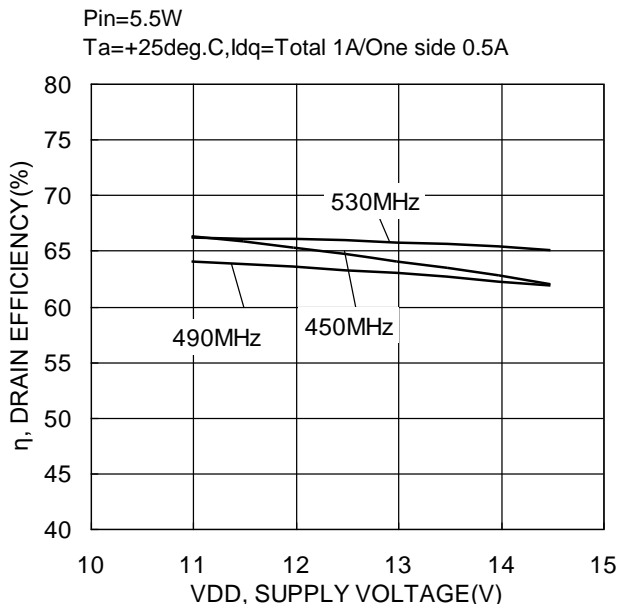

RD70HUF2

RoHS Compliance, Silicon MOSFET Power Transistor, 175MHz, 530MHz, 70W

EQUIVALENT CIRCUITRY for VHF EVALUATION BOARD (f=135 - 175MHz)

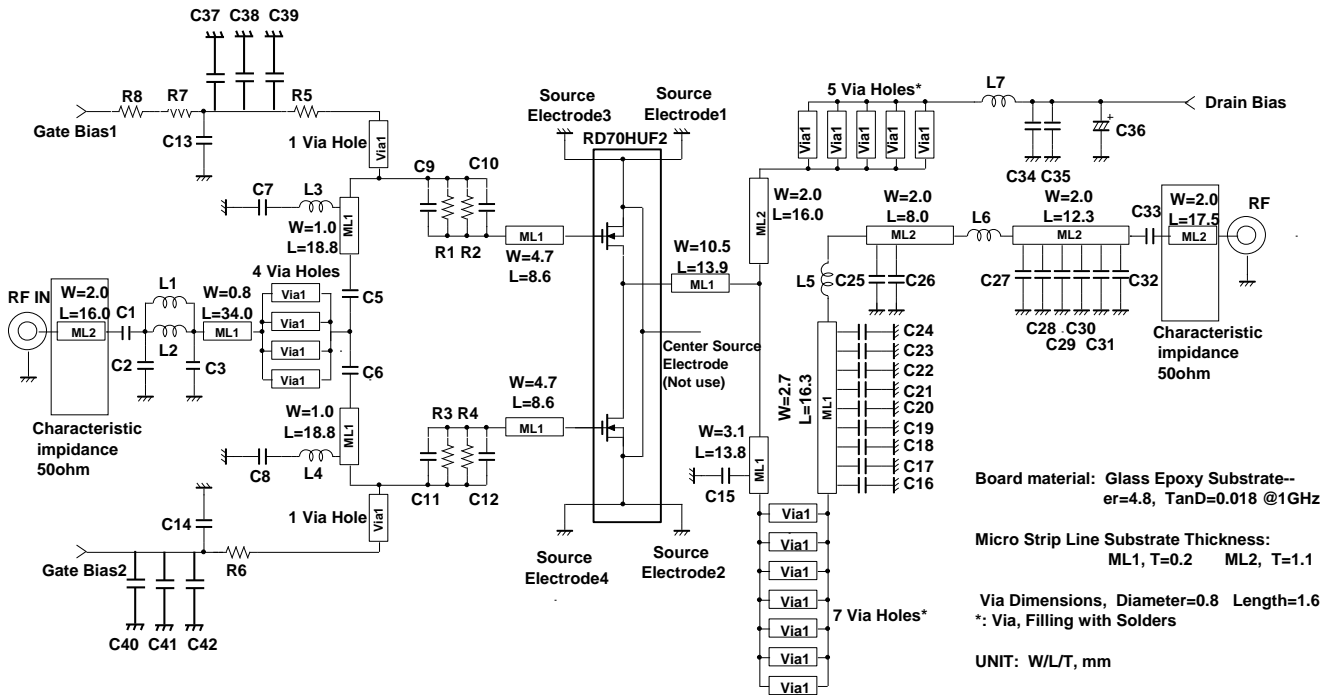

C1	330 pF	3.2*1.6	Chip Ceramic Capacitors
C2,C3	56 pF	1.6*0.8	High Q Chip Ceramic Capacitors
C5, C6	220 pF	1.6*0.8	Chip Ceramic Capacitors
C7, C8	1500 pF	1.6*0.8	Chip Ceramic Capacitors
C9, C10,C11,C12	130 pF	2.0*1.2	Chip Ceramic Capacitors
C13,C14	1000 pF	1.6*0.8	Chip Ceramic Capacitors
C37, C38, C39, C40, C41, C42	1000 pF	2.0*1.2	Chip Ceramic Capacitors
R1, R2, R3, R4	5.6 ohm	2.0*1.2	Chip Resistors
R5, R6	5.6 kohm	1.6*0.8	Chip Resistors
R7, R8	0 ohm	1.6*0.8	Chip Resistors
L1, L2	12 nH	1.6*0.8	Chip Inductors
L3, L4	8 nH	-	2Turn Rolling Coil
C15	47 pF	2.0*1.2	High Q Chip Ceramic Capacitors
C16, C17, C18, C19,C20,C21	68 pF	2.0*1.2	High Q Chip Ceramic Capacitors
C22	15 pF	2.0*1.2	High Q Chip Ceramic Capacitors
C23	8.2 pF	2.0*1.2	High Q Chip Ceramic Capacitors
C24	- pF	-	Non-use
C25	56 pF	2.0*1.2	High Q Chip Ceramic Capacitors
C26	22 pF	2.0*1.2	High Q Chip Ceramic Capacitors
C27,C28, C29, C30, C31, C32	3.9 pF	2.0*1.2	High Q Chip Ceramic Capacitors
C33	330 pF	3.2*1.6	Chip Ceramic Capacitors
C34, C35	390 pF	3.2*1.6	Chip Ceramic Capacitors
C36	220 uF	-	35V, Electrolytic Capacitor
L5	8 nH	-	2Turn Rolling Coil
L6	12 nH	-	3Turn Rolling Coil
L7	17 nH	-	4Turn Rolling Coil

For more information regarding this evaluation board, refer to APPLICATION NOTE "AN-VHF-049"

RD70HUF2

RoHS Compliance, Silicon MOSFET Power Transistor, 175MHz, 530MHz, 70W

EQUIVALENT CIRCUITRY for UHF EVALUATION BOARD (f=450 - 530MHz)

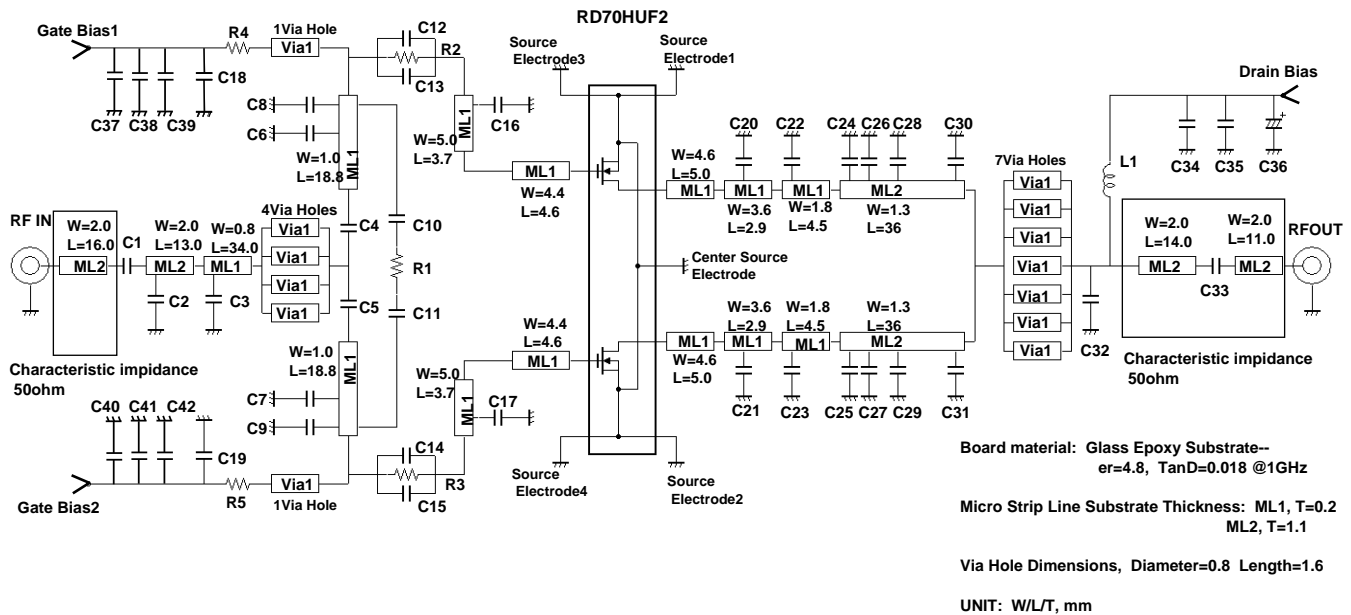

C1	330 pF	3.2*1.6	Chip Ceramic Capacitors
C2	6 pF	1.6*0.8	High Q Chip Ceramic Capacitors
C3	4 pF	1.6*0.8	High Q Chip Ceramic Capacitors
C4, C5	100 pF	1.6*0.8	High Q Chip Ceramic Capacitors
C6, C7	22 pF	1.6*0.8	High Q Chip Ceramic Capacitors
C8, C9	27 pF	1.6*0.8	High Q Chip Ceramic Capacitors
C10, C11	1000 pF	1.6*0.8	Chip Ceramic Capacitors
C12, C13, C14, C15	100 pF	2.0*1.2	High Q Chip Ceramic Capacitors
C16, C17	12 pF	1.6*0.8	High Q Chip Ceramic Capacitors
C18, C19	1000 pF	1.6*0.8	Chip Ceramic Capacitors
C37, C38, C39, C40, C41, C42	1000 pF	2.0*1.2	Chip Ceramic Capacitors
R1	2.2 ohm	2.0*1.2	Chip Resistors
R2, R3	100 ohm	2.0*1.2	Chip Resistors
R4, R5	2.2k ohm	1.6*0.8	Chip Resistors
C20, C21	39 pF	2.0*1.2	High Q Chip Ceramic Capacitors
C22, C23	36 pF	2.0*1.2	High Q Chip Ceramic Capacitors
C24, C25	10 pF	2.0*1.2	High Q Chip Ceramic Capacitors
C26, C27	24 pF	2.0*1.2	High Q Chip Ceramic Capacitors
C28, C29	3.6 pF	2.0*1.2	High Q Chip Ceramic Capacitors
C30, C31	1 pF	2.0*1.2	High Q Chip Ceramic Capacitors
C32	9 pF	2.0*1.2	High Q Chip Ceramic Capacitors
C33	100 pF	3.2*2.5	High Q Chip Ceramic Capacitors
C34, C35	1000 pF	2.0*1.2	Chip Ceramic Capacitors
C36	220 uF	-	35V, Electrolytic Capacitor
L1	25 nH	-	5Turn Rolling Coil

For more information regarding this evaluation board, refer to APPLICATION NOTE "AN-UHF-113"

RD70HUF2

RoHS Compliance, Silicon MOSFET Power Transistor, 175MHz, 530MHz, 70W

Input / Output Impedance VS. Frequency Characteristics

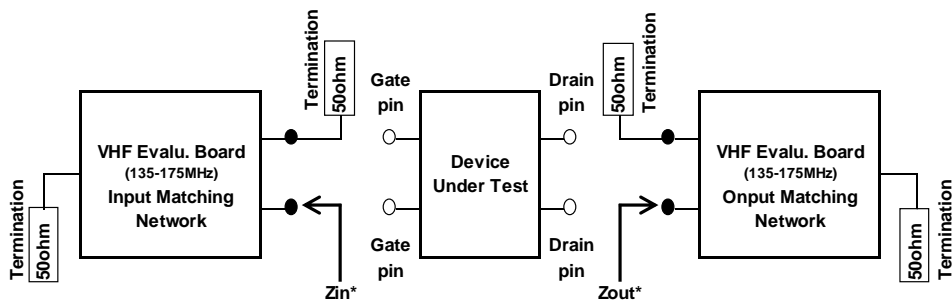
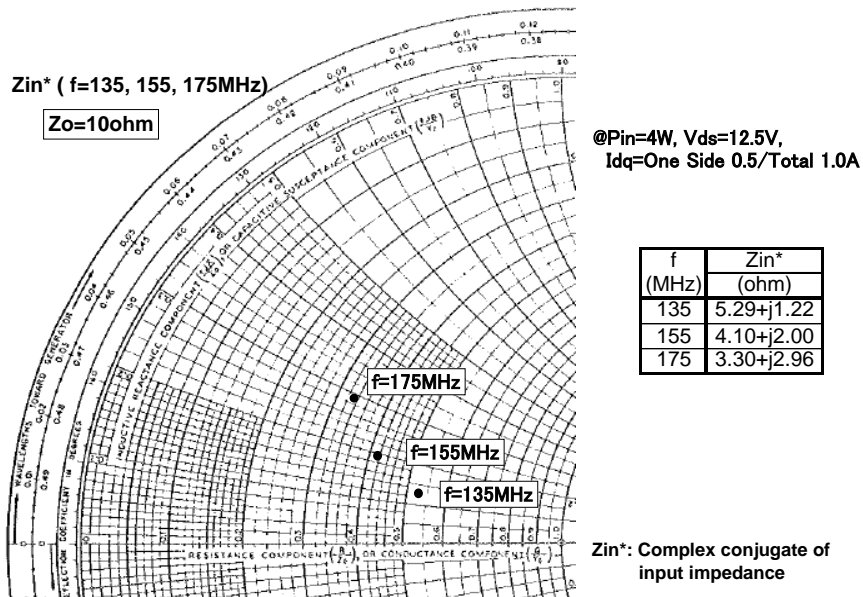
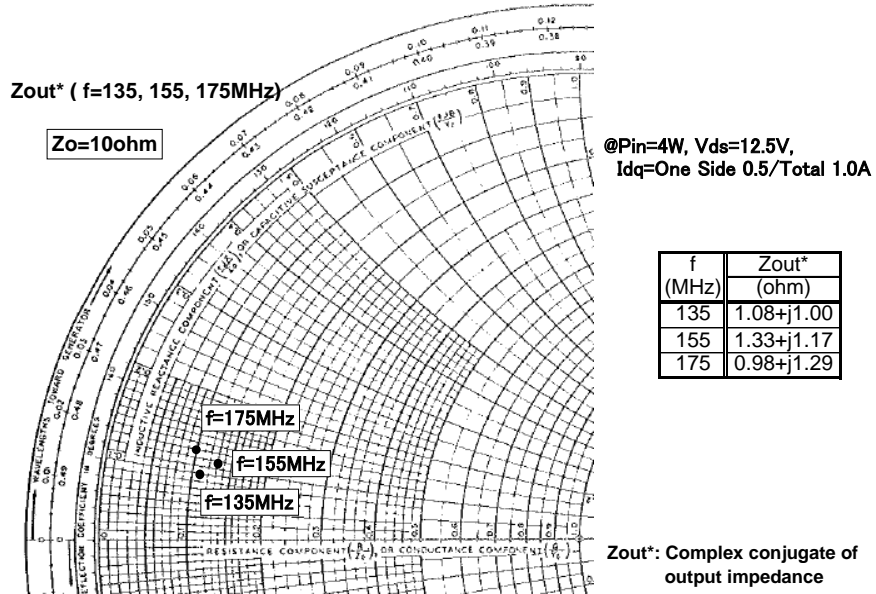

- : Edge of a footprint pad placed for a pin
- : Boundary surface between a pin and package plastics

RD70HUF2

RoHS Compliance, Silicon MOSFET Power Transistor, 175MHz, 530MHz, 70W

Input / Output Impedance VS. Frequency Characteristics

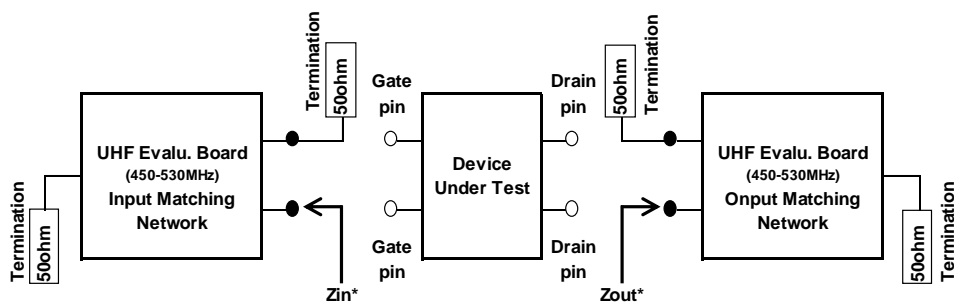
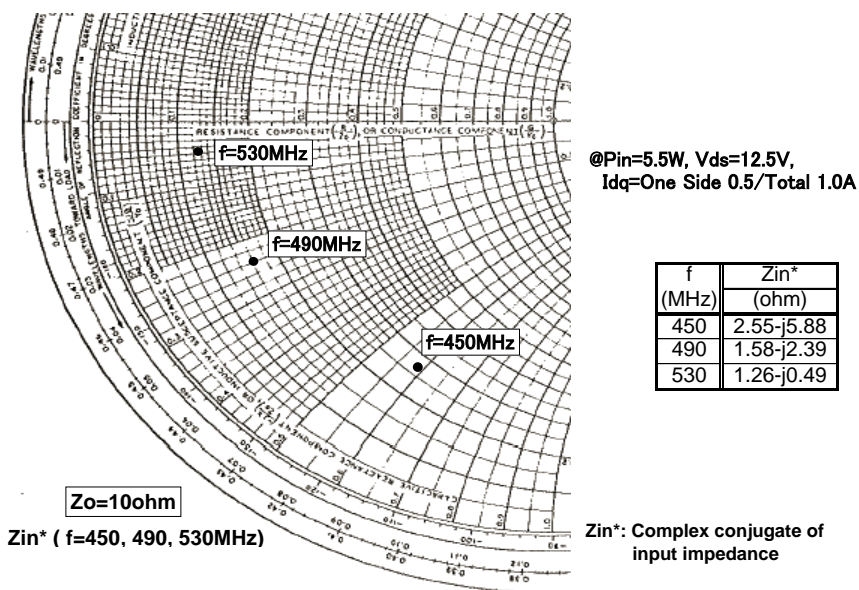
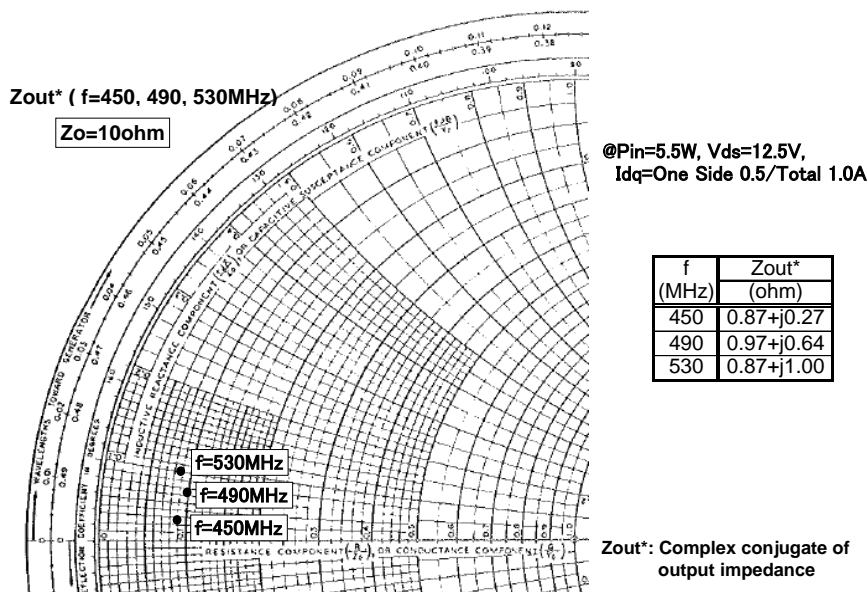

- : Edge of a footprint pad placed for a pin
- : Boundary surface between a pin and package plastics

RD70HUF2

RoHS Compliance, Silicon MOSFET Power Transistor, 175MHz, 530MHz, 70W

Small Signal Parameter of One Side of RD70HUF2

Bias Condition: Vds=12.5V, Idq=One Side 0.5A/Total 1.0A

Freq. (MHz)	S11		S21		S12		S22	
	(mag)	(ang)	(mag)	(ang)	(mag)	(ang)	(mag)	(ang)
100	0.882	-174.5	5.155	69.4	0.009	-14.8	0.847	-174.4
135	0.894	-175.2	3.631	61.8	0.008	-20.1	0.864	-174.4
150	0.899	-175.4	3.188	58.9	0.008	-21.6	0.871	-174.4
175	0.907	-175.8	2.619	54.4	0.007	-24.8	0.884	-174.5
200	0.915	-176.2	2.187	50.1	0.007	-26.5	0.896	-174.8
250	0.929	-177.1	1.594	42.8	0.005	-28.7	0.916	-175.4
300	0.940	-178.0	1.205	36.9	0.004	-27.8	0.931	-176.2
350	0.948	-179.0	0.944	31.6	0.003	-20.1	0.942	-177.1
400	0.955	-179.9	0.755	27.2	0.003	-5.7	0.950	-177.9
450	0.960	179.3	0.616	23.7	0.002	16.0	0.954	-178.7
500	0.964	178.4	0.514	20.4	0.002	34.8	0.957	-179.4
550	0.967	177.5	0.433	17.7	0.003	54.5	0.959	179.9
600	0.970	176.6	0.375	15.4	0.003	63.4	0.962	179.4
650	0.971	175.7	0.322	12.8	0.004	68.9	0.966	178.7
700	0.974	174.9	0.284	11.0	0.005	72.8	0.969	178.1
750	0.974	173.9	0.252	10.1	0.005	75.5	0.973	177.3
800	0.976	173.0	0.228	7.7	0.006	76.5	0.974	176.5
850	0.976	172.0	0.203	6.0	0.007	77.5	0.977	175.6
900	0.977	171.0	0.185	6.5	0.008	78.7	0.977	174.7
950	0.978	170.0	0.164	3.6	0.009	77.5	0.978	173.9
1000	0.979	168.9	0.151	2.5	0.010	76.8	0.978	173.0
1050	0.979	167.8	0.139	0.7	0.011	76.1	0.979	172.1
1100	0.979	166.7	0.130	-0.1	0.011	75.9	0.980	171.0

RD70HUF2

RoHS Compliance, Silicon MOSFET Power Transistor, 175MHz, 530MHz, 70W

ATTENTION:

- 1.High Temperature ; This product might have a heat generation while operation,Please take notice that have a possibility to receive a burn to touch the operating product directly or touch the product until cold after switch off. At the near the product,do not place the combustible material that have possibilities to arise the fire.
- 2.Generation of High Frequency Power ; This product generate a high frequency power. Please take notice that do not leakage the unnecessary electric wave and use this products without cause damage for human and property per normal operation.
- 3.Before use; Before use the product,Please design the equipment in consideration of the risk for human and electric wave obstacle for equipment.

PRECAUTIONS FOR THE USE OF MITSUBISHI SILICON RF POWER DEVICES:

1. The specifications of mention are not guarantee values in this data sheet. Please confirm additional details regarding operation of these products from the formal specification sheet. For copies of the formal specification sheets, please contact one of our sales offices.
- 2.RA series products (RF power amplifier modules) and RD series products (RF power transistors) are designed for consumer mobile communication terminals and were not specifically designed for use in other applications. In particular, while these products are highly reliable for their designed purpose, they are not manufactured under a quality assurance testing protocol that is sufficient to guarantee the level of reliability typically deemed necessary for critical communications elements and In the application, which is base station applications and fixed station applications that operate with long term continuous transmission and a higher on-off frequency during transmitting, please consider the derating, the redundancy system, appropriate setting of the maintain period and others as needed. For the reliability report which is described about predicted operating life time of Mitsubishi Silicon RF Products , please contact Mitsubishi Electric Corporation or an authorized Mitsubishi Semiconductor product distributor.
3. RD series products use MOSFET semiconductor technology. They are sensitive to ESD voltage therefore appropriate ESD precautions are required.
4. In the case of use in below than recommended frequency, there is possibility to occur that the device is deteriorated or destroyed due to the RF-swing exceed the breakdown voltage.
5. In order to maximize reliability of the equipment, it is better to keep the devices temperature low. It is recommended to utilize a sufficient sized heat-sink in conjunction with other cooling methods as needed (fan, etc.) to keep the channel temperature for RD series products lower than 120deg/C(in case of Tchmax=150deg/C) ,140deg/C(in case of Tchmax=175deg/C) under standard conditions.
6. Do not use the device at the exceeded the maximum rating condition. In case of plastic molded devices, the exceeded maximum rating condition may cause blowout, smoldering or catch fire of the molding resin due to extreme short current flow between the drain and the source of the device. These results causes in fire or injury.
7. For specific precautions regarding assembly of these products into the equipment, please refer to the supplementary items in the specification sheet.
8. Warranty for the product is void if the products protective cap (lid) is removed or if the product is modified in any way from it's original form.
9. For additional "Safety first" in your circuit design and notes regarding the materials, please refer the last page of this data sheet.

RD70HUF2

RoHS Compliance, Silicon MOSFET Power Transistor, 175MHz, 530MHz, 70W

10. Please avoid use in the place where water or organic solvents can adhere directly to the product and the environments with the possibility of caustic gas, dust, salinity, etc. Reliability could be markedly decreased and also there is a possibility failures could result causing a serious accident. Likewise, there is a possibility of causing a serious accident if used in an explosive gas environment. Please allow for adequate safety margin in your designs.

11. Please refer to the additional precautions in the formal specification sheet.

Keep safety first in your circuit designs!

Mitsubishi Electric Corporation puts the maximum effort into making semiconductor products better and more reliable, but there is always the possibility that trouble may occur with them. Trouble with semiconductors may lead to personal injury, fire or property damage. Remember to give due consideration to safety when making your circuit designs, with appropriate measures such as (i) placement of substitutive, auxiliary circuits, (ii) use of non-flammable material or (iii) prevention against any malfunction or mishap.

Notes regarding these materials

- These materials are intended as a reference to assist our customers in the selection of the Mitsubishi semiconductor product best suited to the customer's application; they do not convey any license under any intellectual property rights, or any other rights, belonging to Mitsubishi Electric Corporation or a third party.
- Mitsubishi Electric Corporation assumes no responsibility for any damage, or infringement of any third-party's rights, originating in the use of any product data, diagrams, charts, programs, algorithms, or circuit application examples contained in these materials.
- All information contained in these materials, including product data, diagrams, charts, programs and algorithms represents information on products at the time of publication of these materials, and are subject to change by Mitsubishi Electric Corporation without notice due to product improvements or other reasons. It is therefore recommended that customers contact Mitsubishi Electric Corporation or an authorized Mitsubishi Semiconductor product distributor for the latest product information before purchasing a product listed herein. The information described here may contain technical inaccuracies or typographical errors. Mitsubishi Electric Corporation assumes no responsibility for any damage, liability, or other loss rising from these inaccuracies or errors. Please also pay attention to information published by Mitsubishi Electric Corporation by various means, including the Mitsubishi Semiconductor home page (<http://www.MitsubishiElectric.com/>).
- When using any or all of the information contained in these materials, including product data, diagrams, charts, programs, and algorithms, please be sure to evaluate all information as a total system before making a final decision on the applicability of the information and products. Mitsubishi Electric Corporation assumes no responsibility for any damage, liability or other loss resulting from the information contained herein.
- Mitsubishi Electric Corporation semiconductors are not designed or manufactured for use in a device or system that is used under circumstances in which human life is potentially at stake. Please contact Mitsubishi Electric Corporation or an authorized Mitsubishi Semiconductor product distributor when considering the use of a product contained herein for any specific purposes, such as apparatus or systems for transportation, vehicular, medical, aerospace, nuclear, or undersea repeater use.
- The prior written approval of Mitsubishi Electric Corporation is necessary to reprint or reproduce in whole or in part these materials.
- If these products or technologies are subject to the Japanese export control restrictions, they must be exported under a license from the Japanese government and cannot be imported into a country other than the approved destination. Any diversion or re-export contrary to the export control laws and regulations of Japan and/or the country of destination is prohibited.
- Please contact Mitsubishi Electric Corporation or an authorized Mitsubishi Semiconductor product distributor for further details on these materials or the products contained therein.